

OWNER'S MANUAL

THREE-PERSON & FOUR-PERSON CORNER SAUNAS



SA1312/SA1320/SA2412DX/SA2420DX

TABLE OF CONTENTS

ASSEMBLY TIPS & WARNINGS	3
PARTS IDENTIFIER	4
ASSEMBLY INSTRUCTIONS	5-10
OPERATION INSTRUCTIONS	11
ENJOYING YOUR SAUNA	12
HEALTH & SAFETY WARNINGS	13
CLEANING & MAINTANENCE	14
TROUBLESHOOTING GUIDE	14-15
REPLACEMENT PARTS	16-23
WARRANTY INFORMATION	24

The information contained in this manual is subject to change without notice.

ASSEMBLY TIPS & WARNINGS

- Before you begin, read all assembly instructions and safety warnings carefully.
- This sauna requires at least 3 adults to complete assembly.



- Remove all of the contents from boxes and verify that you have all of the parts shown on the Parts Identifier before you begin assembly. *Note: Some parts may be pre-installed or pre-assembled.*
- This manual is used for the assembly of several sauna models; therefore, some figures or drawings may not look exactly like your product.
- Cover the sauna floor during assembly to avoid staining the unfinished wood surface.
- Retain this Owner's Manual for future reference.

ELECTRICAL REQUIREMENTS

- We recommend consulting a licensed electrician and checking local ordinances before installing ANY sauna.
- This sauna requires a 20 amp receptacle and a 20 amp circuit breaker. *Note: Electrical modifications may be required to accommodate 20 amp power.*













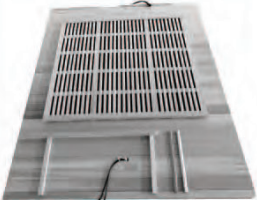











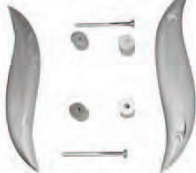





- Refer to the serial plate on the back of the sauna for complete electrical specifications.
- This sauna requires a dedicated circuit - No other appliances should share the same outlet with the sauna.

CHOOSING A LOCATION

- This sauna should only be placed INDOORS on a dry, level surface.
- There should be a minimum of 5 inches clearance between the sauna and any wall.
- Make sure the main power cord will reach the outlet and remains easy to access.
- The sauna should only be used in a dry location as moisture will damage the wood and electrical components.
- Keep the sauna away from any potential hazards including water sources, flammable objects and combustible materials.

PARTS IDENTIFIER (NOT TO SCALE)

 FRONT PANEL WITH GLASS DOOR	 LEFT PANEL	 LEFT BACK PANEL	 RIGHT PANEL	 RIGHT BACK PANEL
 ROOF	 ROOF COVER	 FLOOR	 FLOOR HEATER	 LONG BENCH SEAT
 LONG BENCH HEATER PANEL	 SHORT BENCH SEAT	 SHORT BENCH HEATER PANEL	 BACK REST	 DOOR HANDLE
 STEREO SHELF	 AM/FM CD PLAYER WITH MP3 INPUT¹	 CUP HOLDER	 MAGAZINE RACK	 DOUBLE TOWEL HOOK
 COLOR THERAPY CONTROL PANEL	 OXYGEN IONIZER	 2" (50mm) SCREW²	 1-1/2" (40mm) SCREW²	 1-1/8" (30mm) SCREW²
 3/4" (20mm) SCREW²	ADDITIONAL EQUIPMENT REQUIRED:  PHILLIPS HEAD SCREWDRIVER	 STEP LADDER	¹ Stereo audio cable with 3.5mm (1/8") TRS connector (mini-stereo jack) not included. ² Extra hardware is included - It is normal to have extra screws leftover when sauna assembly is complete. <i>This manual is used for the assembly of several sauna models; therefore, some images or drawings may not look exactly like your product.</i>	

* Refer to REPLACEMENT PARTS (PAGE 16-24) to determine the correct part number when ordering replacements.

ASSEMBLY INSTRUCTIONS

1. Begin assembly by determining an appropriate location for your sauna – see ASSEMBLY TIPS & WARNINGS for details. Attach the FRONT PANEL to the FLOOR by lining up the FRONT PANEL with the groove in the front of the FLOOR.



2. Attach the LEFT PANEL to the FRONT PANEL by aligning the hooks and sliding the LEFT PANEL down, locking it into place.

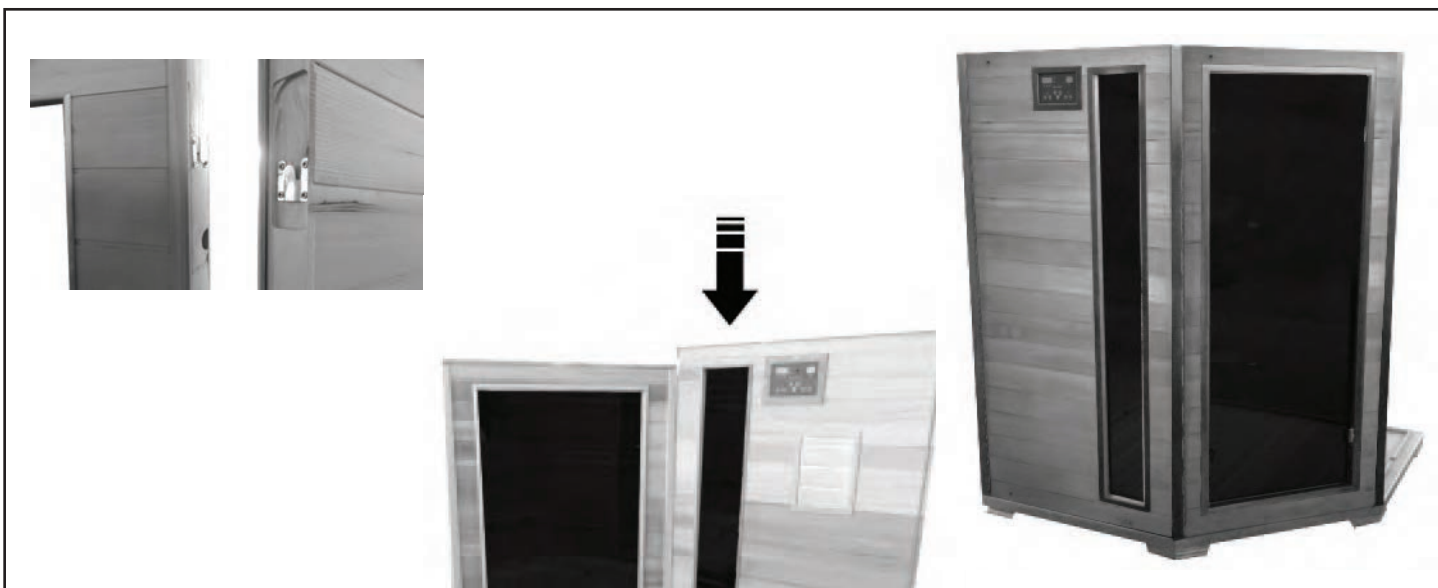

3. Attach the RIGHT PANEL to the FRONT PANEL by aligning the hooks and sliding the RIGHT PANEL down, locking it into place.



ASSEMBLY INSTRUCTIONS (CONT.)

4. Attach the LEFT BACK PANEL to the FLOOR. Buckle the LEFT BACK PANEL to the LEFT PANEL.



5. Attach the RIGHT BACK PANEL to the FLOOR. Buckle the RIGHT BACK PANEL to the RIGHT PANEL and to the LEFT BACK PANEL.



6. Attach the FLOOR HEATER to the FLOOR with 1-1/2" SCREWS. Connect the heater plug.



ASSEMBLY INSTRUCTIONS (CONT.)

7. Slide the LONG BENCH HEATER PANEL into place between the LEFT BACK PANEL and RIGHT PANEL. Connect the heater plug. *Note: It may be necessary to unbuckle the RIGHT PANEL from the RIGHT BACK PANEL in order to slide the LONG BENCH HEATER PANEL into place.*



8. Slide the SHORT BENCH HEATER PANEL into place between the LONG BENCH HEATER PANEL and LEFT PANEL. Connect the heater plug. *Note: Make sure the FLOOR HEATER cable is placed through the groove in the bottom of the SHORT BENCH HEATER PANEL.*



9. Attach LONG BENCH SEAT with 2" SCREWS.

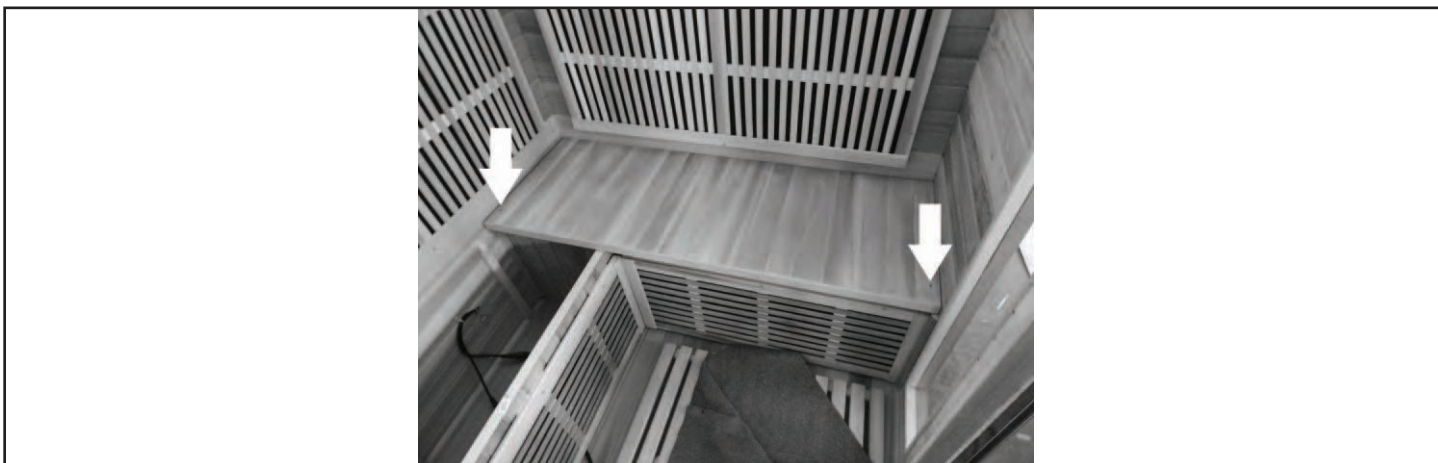

ASSEMBLY INSTRUCTIONS (CONT.)

10. Attach SHORT BENCH SEAT with 2" SCREWS.

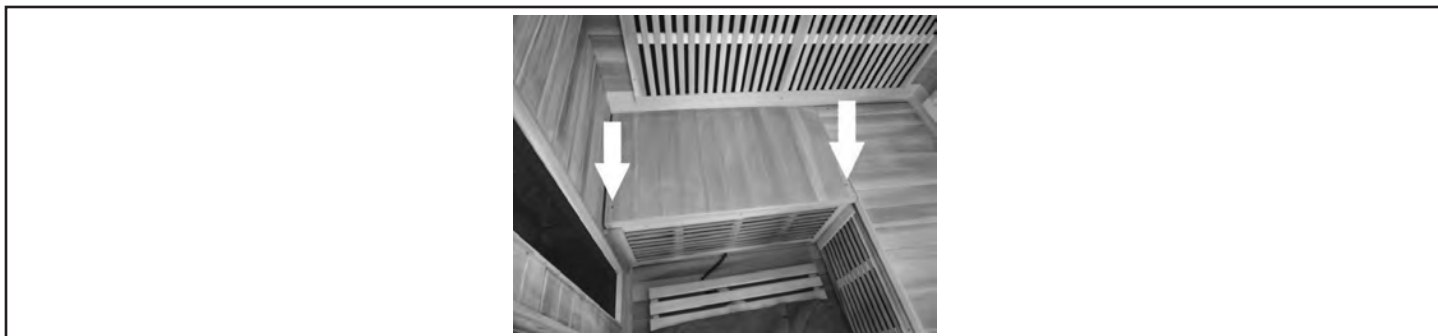

11. Lift the ROOF above the sauna, feeding the control panel and heater cables through the corresponding holes. Feed the cables for the AM/FM CD PLAYER through the hole in the bottom of the ROOF. Secure the ROOF to the sauna with 1-1/8" SCREWS. Connect the control panel and heater plugs.



12. Feed the main power cable through hole in ROOF and plug securely into receptacle on back of POWER SUPPLY box . Secure the ROOF COVER with 3/4" SCREWS.



ASSEMBLY INSTRUCTIONS (CONT.)

13. Attach the DOOR HANDLE to the GLASS DOOR.



14. Gently pull the cables for the AM/FM CD PLAYER through the opening in the front of the STEREO SHELF. Attach the STEREO SHELF with 3/4" SCREWS.



15. Plug the controller and antenna into the back of the AM/FM CD PLAYER. *Note: The red and white cables are used for an optional video player and can be tucked out of the way. Slide and lock the AM/FM CD PLAYER into the STEREO SHELF. Note: Use included "keys" if you need to remove the CD player for maintenance at a later date.*



16. Attach the MAGAZINE RACK with 1-1/2" SCREWS. *Note: A sticker indicates the optimal position for this accessory, but attaching it is optional. Consider the position carefully before driving any screws into the sauna interior.*

ASSEMBLY INSTRUCTIONS (CONT.)

17. Attach the CUP HOLDER(S) with 3/4" SCREWS. *Note: A sticker indicates the optimal position for this accessory, but attaching it is optional. Consider the position carefully before driving any screws into the sauna interior.*

18. Attach the DOUBLE TOWEL HOOK with 3/4" SCREWS. *Note: A sticker indicates the optimal position for this accessory, but attaching it is optional. Consider the position carefully before driving any screws into the sauna interior.*

19. Attach the COLOR THERAPY CONTROL PANEL into the designated position with 2" SCREWS.



20. Remove the back cover of the OXYGEN IONIZER by turning it as indicated. Unwrap and install the fragrance patch, then reattach the back cover. Attach the OXYGEN IONIZER in the designated position with 3/4" SCREWS. Plug the power cable into the OXYGEN IONIZER.



21. Plug the main power cable into a dedicated outlet. *Note: No other appliances should share the same outlet with this sauna.*

CONGRATULATIONS!

The assembly of your sauna is now complete.

Please review the Operation Instructions and Health & Safety warnings before using your sauna.

To ensure years of trouble-free use, follow the Cleaning & Maintenance guidelines carefully.

OPERATION INSTRUCTIONS

SAUNA CONTROL PANEL

Note: The sauna controls are the same for both the interior and exterior Control Panels.

1. Press POWER to turn ON the sauna.
2. Set the desired TEMPERATURE with the (+) and (-) buttons.
3. Press and hold both (+) and (-) to switch between °F (Fahrenheit) and °C (Celsius).
4. Set the desired TIME with the (+) and (-) buttons.
5. Press INSIDE or OUTSIDE to turn on or off the corresponding light.
6. When the TIME reaches 00, the heaters will turn OFF automatically.
7. After your sauna session, press POWER to turn OFF the sauna.

COLOR THERAPY CONTROL PANEL

1. Press POWER to turn ON the Color Therapy Light. The Color Therapy Light will cycle through all the available colors.
2. Press SELECT to locate your preferred color or pattern, then press SET.
3. Set the desired TIME with the (+) and (-) buttons, then press SET.
4. Press POWER to turn OFF the Color Therapy Light.

OXYGEN IONIZER

1. Press ION to release negatively charged ions to purify the air.
2. Press O3 to disinfect the air with ozone.

ENJOYING YOUR SAUNA

1. Prior to initial use, wipe down all interior surfaces of the sauna with a damp cloth.
2. Turn on the sauna and set temperature to 104° F for one hour to burn off any factory dust.
3. Always drink plenty of water before, during and after your sauna session to stay properly hydrated.
4. A normal sauna session should last 30 minutes or less.
5. Allow approximately 15 to 25 minutes for the sauna to warm up before entering.
6. Perspiration will begin within 15 to 25 minutes after entering the sauna.
7. Limit the use of lotions or oils on your body while using your sauna. These products can block your pores and limit perspiration, decreasing the effectiveness of your sauna session.
8. For spot treatment of a particular area, position that body part closer to the heater, allowing for deeper heating in that area.
9. During your sauna session, place towels on the bench seats and on the floor to absorb perspiration and maintain the cleanliness of your sauna.
10. Towel off excess perspiration during your sauna session to help your body perspire more freely.
11. Open the ceiling vent or the front door to allow fresh air into your sauna.
12. Allow your body to cool down following your sauna session, then rinse the perspiration off your body in a warm shower.

HEALTH & SAFETY WARNINGS

1. Review all instructions and warnings before operating your sauna. A sauna is not a toy. Serious injury may result from negligence, intentional misuse and failure to follow safety instructions.
2. **Hyperthermia Danger:** Hyperthermia occurs when the body absorbs more heat than it can dissipate. When the elevated body temperatures are sufficiently high, hyperthermia is a medical emergency and requires immediate treatment to prevent disability or death. It is very important not to allow your body's core temperature to rise above 103° F. Symptoms of hyperthermia include dizziness, lethargy, drowsiness and fainting. The effects of hyperthermia may include failure to perceive heat, failure to recognize the need to exit the sauna, unawareness of the impending health hazard, physical inability to exit the sauna and unconsciousness.
3. If you are feeling uncomfortable, faint or dizzy, exit the sauna immediately.
4. Do not exceed recommended time and temperature guidelines.
5. Do not touch or interfere with the temperature sensor on the control panel.
6. Do not touch or spray water on the heater elements.
7. Do not use the sauna while under the influence of drugs or alcohol.
8. Do not sleep inside the sauna.
9. Do not use the sauna immediately following strenuous exercise. Allow your body to cool down for 30 minutes before entering the sauna.
10. Pets should never be placed in the sauna.
11. Pregnant women, children under the age of 6, the elderly and infirm should not use the sauna.
12. Children over the age of 6 should always be supervised by an adult.
13. People with health problems including open wounds, fever, sunburn or dehydration should not use the sauna.
14. People suffering from obesity or with a history of heart disease, low or high blood pressure, circulatory system problems or diabetes should consult a physician before using the sauna.
15. Consult a physician before using the sauna if you take any prescription medications.
16. Keep towels and combustible materials away from the heater elements.
17. Remove all towels and materials after your sauna session.
18. Never leave your sauna unattended while in use.
19. Always unplug the sauna and allow it to cool down before performing any cleaning or maintenance.
20. Always turn off and unplug the sauna when not in use.

CLEANING & MAINTENANCE

1. Always unplug the sauna and allow it to cool down before performing any cleaning or maintenance.
2. Use furniture polish or furniture oil when cleaning the sauna exterior.
3. The sauna interior surfaces should only be wiped down with a damp cloth. Do NOT use chemicals, abrasive cleaners or solvents on the unfinished interior wood.
4. As with all natural wood products, variations in the color and the grain as well as irregularities such as knots and fine cracks may be present. These characteristics are a part of the natural beauty of the wood and should not be considered defective.

TROUBLESHOOTING GUIDE

WARNING!

- Always unplug the sauna and allow it to cool down before performing any maintenance.
- Repairs to the electrical components of the sauna should only be performed by a qualified service technician.
- Unauthorized repairs or alterations will void the manufacturer's warranty.

Problem **THERE IS NO POWER TO THE SAUNA**

- Solution**
1. Check that the Main Power Cable is plugged into the wall outlet.
 2. Check that the circuit breaker for the outlet has not tripped. If the breaker has tripped, check that the amperage of the breaker is appropriate for your sauna.
 3. Check all connections to the Power Supply Box.
 4. Check for damage to the Main Power Cable; replace, if necessary.
 5. Replace the Power Supply Box, if necessary.



Problem **ONE HEATER DOES NOT WORK**

- Solution**
1. Check that all the connections are tight.
 2. Replace the Heater Element.

Problem **NONE OF THE HEATERS WORK**

- Solution**
1. Check that all connections are tight.
 2. Replace the Heater Circuit Board, if necessary.

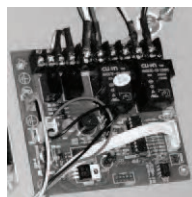

TROUBLESHOOTING GUIDE (CONT.)

Problem THE CONTROL PANEL DOES NOT WORK

- Solution**
1. Check that all the connections are tight.
 2. If the numbers are scrambled or the buttons are unresponsive, replace the Control Panel.
 3. If the temperature indicator does not work or reads "--" or "EP", replace the Control Panel.

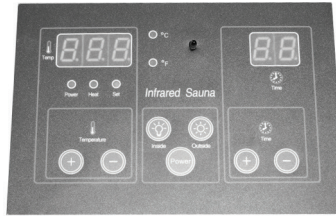

Problem THE LIGHTS ARE NOT WORKING

- Solution**
1. Check that all the connections are tight.
 2. If one light does not work, replace the bulb. *Note: Do not touch the glass part of the bulb with your fingers during installation.*
 3. If neither the lights nor the radio are working, replace the Power Supply Box.

Problem THE RADIO AND/OR CD PLAYER IS NOT WORKING

- Solution**
1. Check that all the connections are tight.
 2. Check the fuse; replace if necessary.
 3. Replace the radio.
 4. If neither the radio nor the lights are working, replace the Power Supply Box.

Problem THE SPEAKERS ARE NOT WORKING

- Solution**
1. Check that the volume is not turned all the way down and that the fader control is set correctly.
 2. If only one speaker is working, check to see that the sound balance on the stereo is not set all the way to one side.
 3. Check that all the connections are tight.
 4. Replace the speaker, if necessary.

Problem THE COLOR THERAPY LIGHTS ARE NOT WORKING

- Solution**
1. Check that all the connections are tight.
 2. Replace the Color Therapy Light or Color Therapy Control Panel, if necessary.

REPLACEMENT PARTS

The following pages list part numbers specific to your particular sauna model. Please reference the model number at the top of each page to make sure you're using the correct list for your sauna. In the event that you need replacement parts, use these guides to reference the part number. It is important to use only replacement parts specified by the manufacturer. The use of unauthorized substitutes may damage your sauna or cause electrical hazards resulting in injury or fire.

REPLACEMENT PARTS

Rev. 8/14

SA1312 THREE-PERSON CEDAR CORNER SAUNA

REF. #	DESCRIPTION	PART NUMBER	QTY.
1	FRONT PANEL with GLASS DOOR	SAP30204	1
2	RIGHT PANEL	SAP30234	1
3	LEFT PANEL	SAP30214	1
4	LEFT BACK PANEL	SAP30224	1
5	RIGHT BACK PANEL	SAP30244	1
6	CONTROL PANEL	SAP2406	1
7	ROOF	SAP30254	1
8	ROOF COVER	SAP3026	1
9	FLOOR	SAP3027	1
10	GLASS DOOR	SAP24574	1
10	GLASS CLIP - METAL	SAP2537	2
10	DOOR MAGNET	SAP25371	2
12	FLOOR HEATER	SAP3028	1
13,14	330W HEATER ELEMENT – LEFT BACK PANEL	SAP2418	2
13,14	330W HEATER ELEMENT – RIGHT BACK PANEL	SAP2418	2
15	POWER SUPPLY BOX	SAP2407	1
15	POWER SUPPLY RECEPTACLE	SAP24073	1
15	HEATER CIRCUIT BOARD	SAP2428	1
15	25 AMP OVERCURRENT PROTECTOR	SAP2530	1
16,17	180W HEATER ELEMENT – LONG BENCH HEATER	SAP2419	1
16,17	180W HEATER ELEMENT – SHORT BENCH HEATER	SAP2419	1
18	STEREO SHELF	SAP30124	1
19	AM/FM CD PLAYER with USB INPUT	SAP24084	1
20	OXYGEN IONIZER	SAP2409	1
21	BACKREST	SAP3010	3
22	80W HEATER ELEMENT – FLOOR HEATER	SAP2420	1
23	DOOR HANDLE	SAP3011	1 SET
24	EXTERIOR LIGHT BULB	SAP2404	2
24,27	LIGHT HOUSING	SAP2606	6
25	DOOR HINGE	SAP24154	2
26	COLOR THERAPY CONTROL PANEL	SAP3112	1
26	COLOR THERAPY CONTROL PANEL FRAME	SAP3016	1
27	INTERIOR LIGHT BULB	SAP2404	4
28	COLOR THERAPY LIGHT	SAP2410	1
29,39	SPEAKER	SAP2416	2
30	THERMOSTAT WIRE	SAP25314	1
31	LONG BENCH SEAT	SAP3029	1
32	LONG BENCH HEATER PANEL	SAP30304	1
32	SHORT BENCH HEATER PANEL	SAP30324	1
33	MAGAZINE RACK	SAP3014	1
34	CUP HOLDER	SAP3013	2
35	DOUBLE TOWEL HOOK	SAP3015	1
36	MAIN POWER CABLE	SAP2704	1
37	2" (50mm) SCREW	SAP2411	6
37	1-1/2" (40mm) SCREW	SAP2411	10
37	1-1/8" (30mm) SCREW	SAP2411	8
37	3/4" (20mm) SCREW	SAP2411	35
38	SHORT BENCH SEAT	SAP3031	1
---	BUCKLE	SAP2607	9
---	WOODEN POWER CABLE COVER	SAP3128	1
---	COLOR THERAPY CONTROL PANEL 4 PRONG WIRE	SAP2532	1
---	COLOR THERAPY CONTROL PANEL 5 PRONG WIRE	SAP2533	1
---	CONTROL PANEL WIRE	SAP2536	1

Please see drawing on next page to assist in identifying parts.

SA1312

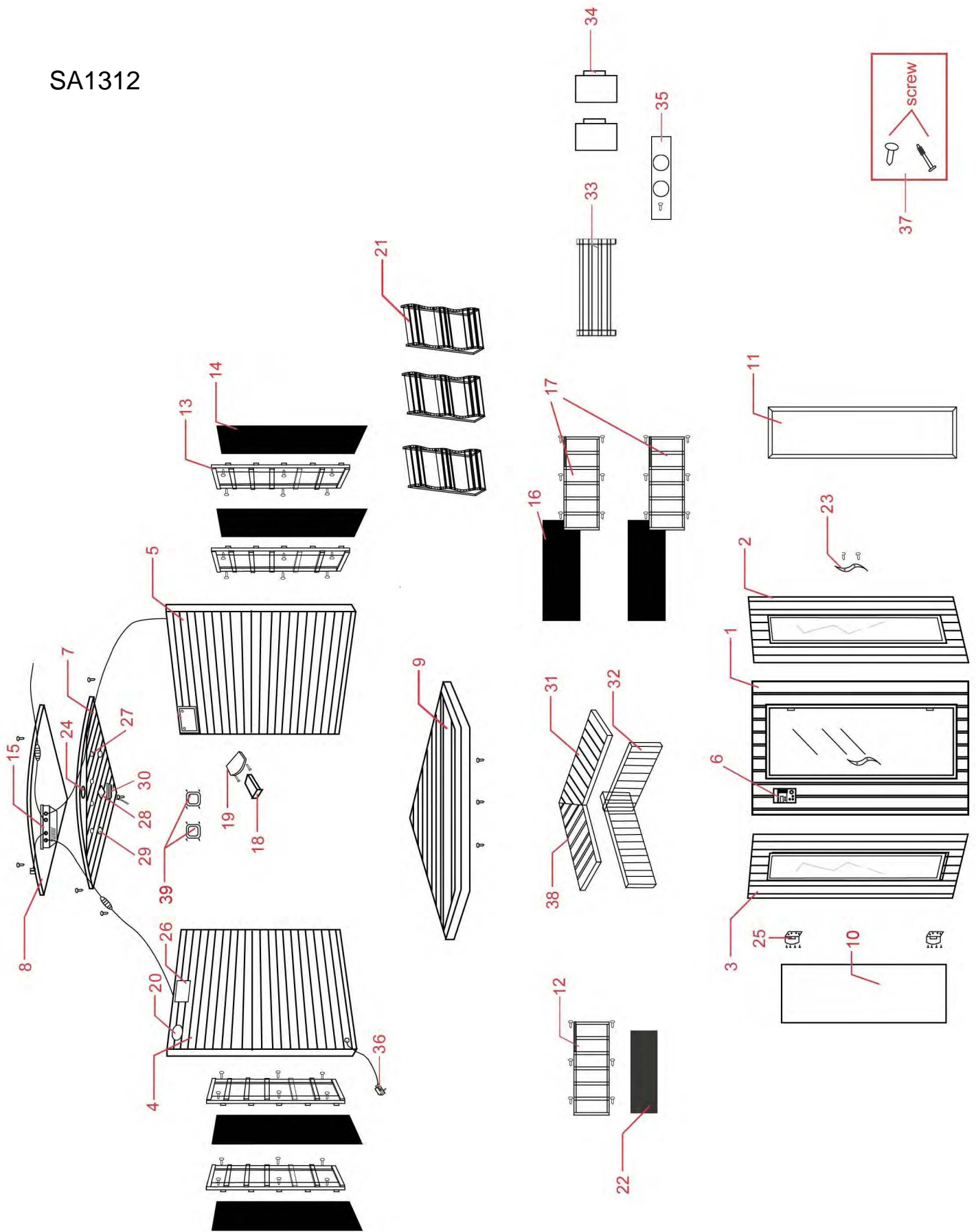

REPLACEMENT PARTS

Rev. 8/14

SA1320 FOUR-PERSON CEDAR CORNER SAUNA

REF. #	DESCRIPTION	PART NUMBER	QTY.
1	FRONT PANEL with GLASS DOOR	SAP30434	1
2	RIGHT PANEL	SAP30464	1
3	LEFT PANEL	SAP30444	1
4	LEFT BACK PANEL	SAP30454	1
5	RIGHT BACK PANEL	SAP30474	1
6	CONTROL PANEL	SAP2406	1
7	ROOF	SAP30484	1
8	ROOF COVER	SAP3049	1
9	FLOOR	SAP3050	1
10	GLASS DOOR	SAP24574	1
10	GLASS CLIP - METAL	SAP2537	2
10	DOOR MAGNET	SAP25371	2
12	FLOOR HEATER	SAP3051	1
13,14	300W HEATER ELEMENT – LEFT BACK PANEL – MIDDLE	SAP2422	1
13,14	225W HEATER ELEMENT – LEFT BACK PANEL	SAP2421	2
13,14	300W HEATER ELEMENT – RIGHT BACK PANEL – MIDDLE	SAP2422	1
13,14	225W HEATER ELEMENT – RIGHT BACK PANEL	SAP2421	2
15	POWER SUPPLY BOX	SAP2407	1
15	POWER SUPPLY RECEPTACLE	SAP24073	1
15	HEATER CIRCUIT BOARD	SAP2428	1
15	25 AMP OVERCURRENT PROTECTOR	SAP2530	1
16,17	180W HEATER ELEMENT – LONG BENCH HEATER	SAP2419	1
16,17	180W HEATER ELEMENT – SHORT BENCH HEATER	SAP2419	1
18	STEREO SHELF	SAP30124	1
19	AM/FM CD PLAYER with USB INPUT	SAP24084	1
20	OXYGEN IONIZER	SAP2409	1
21	BACKREST	SAP3010	4
22	180W HEATER ELEMENT – FLOOR HEATER	SAP2419	1
22	80W HEATER ELEMENT – FLOOR HEATER	SAP2420	1
23	DOOR HANDLE	SAP3011	1 SET
24	EXTERIOR LIGHT BULB	SAP2404	2
24,27	LIGHT HOUSING	SAP2606	6
25	DOOR HINGE	SAP24154	2
26	COLOR THERAPY CONTROL PANEL	SAP3112	1
26	COLOR THERAPY CONTROL PANEL FRAME	SAP3016	1
27	INTERIOR LIGHT BULB	SAP2404	4
28	COLOR THERAPY LIGHT	SAP2410	1
29,39	SPEAKER	SAP2416	2
30	THERMOSTAT WIRE	SAP25314	1
31	LONG BENCH SEAT	SAP3052	1
32	LONG BENCH HEATER PANEL	SAP30534	1
32	SHORT BENCH HEATER PANEL	SAP30554	1
33	MAGAZINE RACK	SAP3014	1
34	CUP HOLDER	SAP3013	2
35	DOUBLE TOWEL HOOK	SAP3015	1
36	MAIN POWER CABLE	SAP2704	1
37	2" (50mm) SCREW	SAP2411	6
37	1-1/2" (40mm) SCREW	SAP2411	10
37	1-1/8" (30mm) SCREW	SAP2411	8
37	3/4" (20mm) SCREW	SAP2411	35
38	SHORT BENCH SEAT	SAP3054	1
---	BUCKLE	SAP2607	9
---	WOODEN POWER CABLE COVER	SAP3128	1
---	COLOR THERAPY CONTROL PANEL 4 PRONG WIRE	SAP2532	1
---	COLOR THERAPY CONTROL PANEL 5 PRONG WIRE	SAP2533	1
---	CONTROL PANEL WIRE	SAP2536	1

Please see drawing on next page to assist in identifying parts.

SA1320

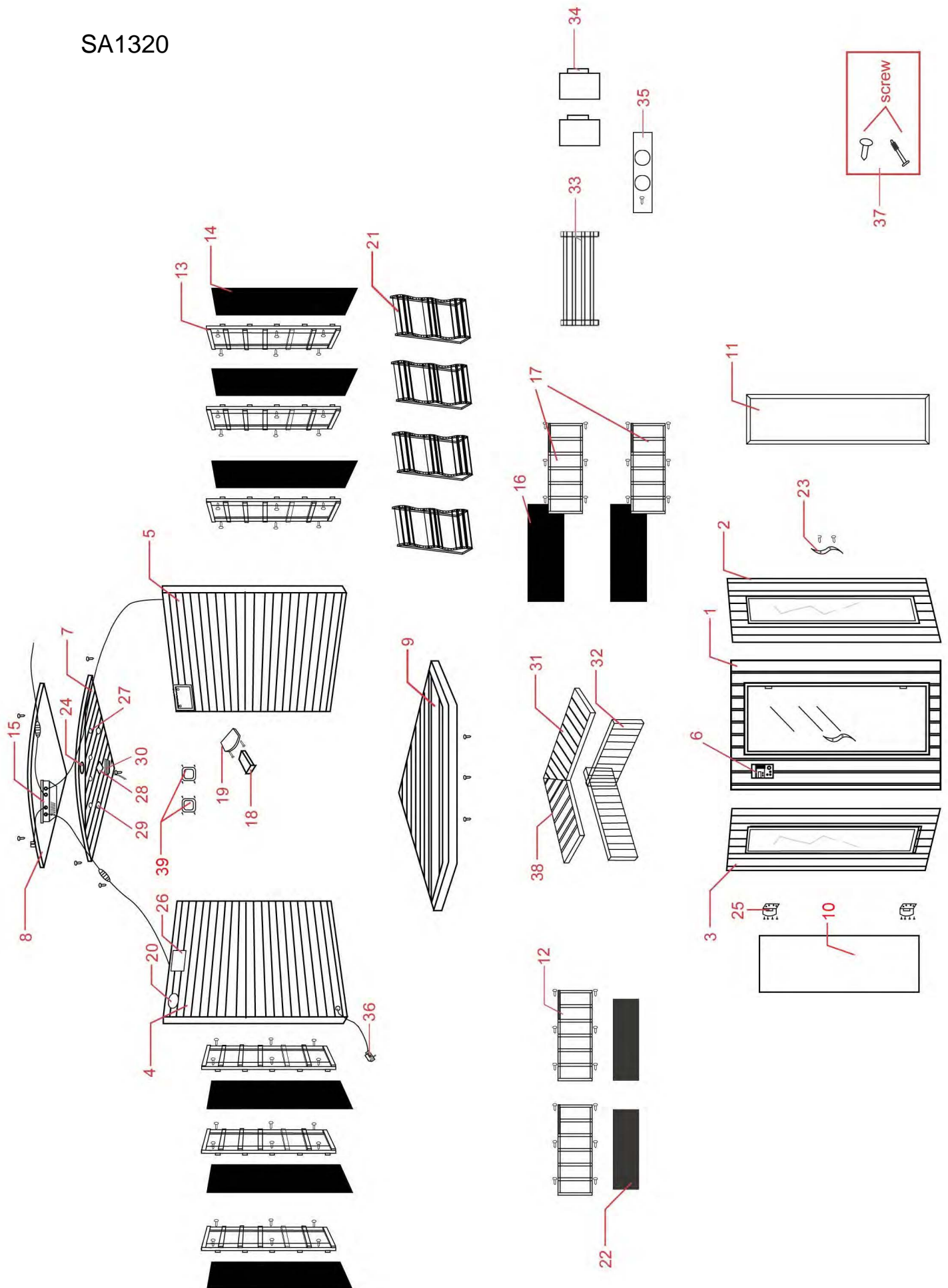

REPLACEMENT PARTS

Rev. 8/14

SA2412DX THREE-PERSON HEMLOCK CORNER SAUNA

REF. #	DESCRIPTION	PART NUMBER	QTY.
1	FRONT PANEL with GLASS DOOR	SAP31134	1
2	RIGHT PANEL	SAP31164	1
3	LEFT PANEL	SAP31144	1
4	LEFT BACK PANEL	SAP31154	1
5	RIGHT BACK PANEL	SAP31174	1
6	CONTROL PANEL	SAP2406	1
7	ROOF	SAP31184	1
8	ROOF COVER	SAP3026	1
9	FLOOR	SAP3119	1
10	GLASS DOOR	SAP24574	1
10	GLASS CLIP - METAL	SAP2537	2
10	DOOR MAGNET	SAP25371	2
12	FLOOR HEATER	SAP3120	1
13,14	330W HEATER ELEMENT – LEFT BACK PANEL	SAP2418	2
13,14	330W HEATER ELEMENT – RIGHT BACK PANEL	SAP2418	2
15	POWER SUPPLY BOX	SAP2407	1
15	POWER SUPPLY RECEPTACLE	SAP24073	1
15	HEATER CIRCUIT BOARD	SAP2428	1
15	25 AMP OVERCURRENT PROTECTOR	SAP2530	1
16,17	180W HEATER ELEMENT – LONG BENCH HEATER	SAP2419	1
16,17	180W HEATER ELEMENT – SHORT BENCH HEATER	SAP2419	1
18	STEREO SHELF	SAP24024	1
19	AM/FM CD PLAYER with USB INPUT	SAP24084	1
20	OXYGEN IONIZER	SAP2409	1
21	BACKREST	SAP2412	3
22	80W HEATER ELEMENT – FLOOR HEATER	SAP2420	1
23	DOOR HANDLE	SAP2413	1 SET
24	EXTERIOR LIGHT BULB	SAP2404	2
24,27	LIGHT HOUSING	SAP2606	6
25	DOOR HINGE	SAP24154	2
26	COLOR THERAPY CONTROL PANEL	SAP2427	1
26	COLOR THERAPY CONTROL PANEL FRAME	SAP2417	1
27	INTERIOR LIGHT BULB	SAP2404	4
28	COLOR THERAPY LIGHT	SAP2410	1
29,39	SPEAKER	SAP2416	2
30	THERMOSTAT WIRE	SAP25314	1
31	LONG BENCH SEAT	SAP3121	1
32	LONG BENCH HEATER PANEL	SAP31224	1
32	SHORT BENCH HEATER PANEL	SAP31244	1
33	MAGAZINE RACK	SAP2414	1
34	CUP HOLDER	SAP2444	2
35	DOUBLE TOWEL HOOK	SAP2460	1
36	MAIN POWER CABLE	SAP2704	1
37	2" (50mm) SCREW	SAP2411	6
37	1-1/2" (40mm) SCREW	SAP2411	10
37	1-1/8" (30mm) SCREW	SAP2411	8
37	3/4" (20mm) SCREW	SAP2411	35
38	SHORT BENCH SEAT	SAP3123	1
---	BUCKLE	SAP2607	9
---	WOODEN POWER CABLE COVER	SAP3128	1
---	COLOR THERAPY CONTROL PANEL 4 PRONG WIRE	SAP2532	1
---	COLOR THERAPY CONTROL PANEL 5 PRONG WIRE	SAP2533	1
---	CONTROL PANEL WIRE	SAP2536	1

Please see drawing on next page to assist in identifying parts.

SA2412DX

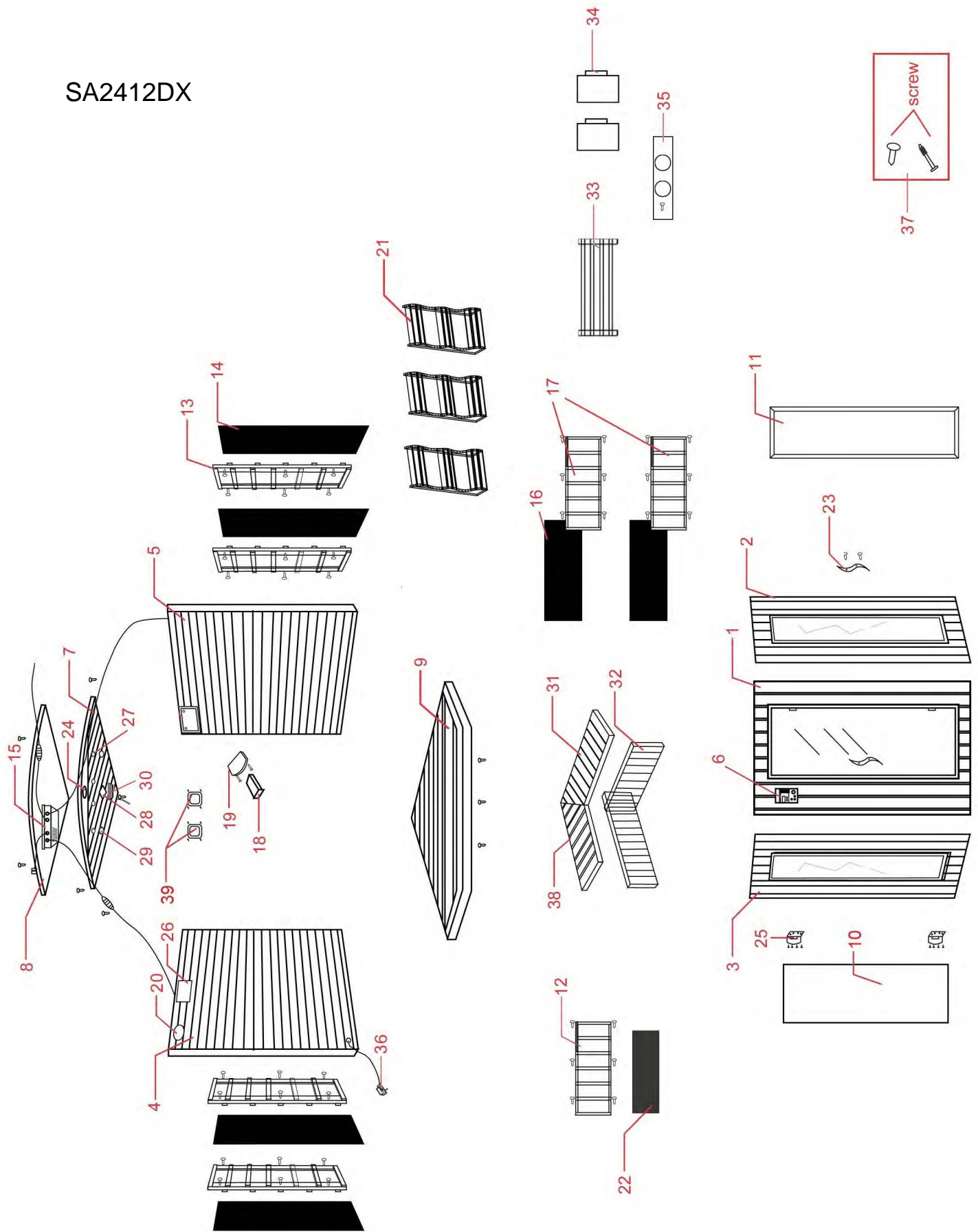

REPLACEMENT PARTS

Rev. 8/14

SA2420DX FOUR-PERSON HEMLOCK CORNER SAUNA

REF. #	DESCRIPTION	PART NUMBER	QTY.
1	FRONT PANEL with GLASS DOOR	SAP31004	1
2	RIGHT PANEL	SAP31034	1
3	LEFT PANEL	SAP31014	1
4	LEFT BACK PANEL	SAP31024	1
5	RIGHT BACK PANEL	SAP31044	1
6	CONTROL PANEL	SAP2406	1
7	ROOF	SAP31054	1
8	ROOF COVER	SAP3049	1
9	FLOOR	SAP3106	1
10	GLASS DOOR	SAP24574	1
10	GLASS CLIP - METAL	SAP2537	2
10	DOOR MAGNET	SAP25371	2
12	FLOOR HEATER	SAP3107	1
13,14	300W HEATER ELEMENT – LEFT BACK PANEL – MIDDLE	SAP2422	1
13,14	225W HEATER ELEMENT – LEFT BACK PANEL	SAP2421	2
13,14	300W HEATER ELEMENT – RIGHT BACK PANEL – MIDDLE	SAP2422	1
13,14	225W HEATER ELEMENT – RIGHT BACK PANEL	SAP2421	2
15	POWER SUPPLY BOX	SAP2407	1
15	POWER SUPPLY RECEPTACLE	SAP24073	1
15	HEATER CIRCUIT BOARD	SAP2428	1
15	25 AMP OVERCURRENT PROTECTOR	SAP2530	1
16,17	180W HEATER ELEMENT – LONG BENCH HEATER	SAP2419	1
16,17	180W HEATER ELEMENT – SHORT BENCH HEATER	SAP2419	1
18	STEREO SHELF	SAP24024	1
19	AM/FM CD PLAYER with USB INPUT	SAP24084	1
20	OXYGEN IONIZER	SAP2409	1
21	BACKREST	SAP2412	4
22	180W HEATER ELEMENT – FLOOR HEATER	SAP2419	1
22	80W HEATER ELEMENT – FLOOR HEATER	SAP2420	1
23	DOOR HANDLE	SAP2413	1 SET
24	EXTERIOR LIGHT BULB	SAP2404	2
24,27	LIGHT HOUSING	SAP2606	6
25	DOOR HINGE	SAP24154	2
26	COLOR THERAPY CONTROL PANEL	SAP2427	1
26	COLOR THERAPY CONTROL PANEL FRAME	SAP2417	1
27	INTERIOR LIGHT BULB	SAP2404	4
28	COLOR THERAPY LIGHT	SAP2410	1
29,39	SPEAKER	SAP2416	2
30	THERMOSTAT WIRE	SAP25314	1
31	LONG BENCH SEAT	SAP3108	1
32	LONG BENCH HEATER PANEL	SAP31094	1
32	SHORT BENCH HEATER PANEL	SAP31114	1
33	MAGAZINE RACK	SAP2414	1
34	CUP HOLDER	SAP2444	2
35	DOUBLE TOWEL HOOK	SAP2460	1
36	MAIN POWER CABLE	SAP2704	1
37	2" (50mm) SCREW	SAP2411	6
37	1-1/2" (40mm) SCREW	SAP2411	10
37	1-1/8" (30mm) SCREW	SAP2411	8
37	3/4" (20mm) SCREW	SAP2411	35
38	SHORT BENCH SEAT	SAP3110	1
---	BUCKLE	SAP2607	9
---	WOODEN POWER CABLE COVER	SAP3128	1
---	COLOR THERAPY CONTROL PANEL 4 PRONG WIRE	SAP2532	1
---	COLOR THERAPY CONTROL PANEL 5 PRONG WIRE	SAP2533	1
---	CONTROL PANEL WIRE	SAP2536	1

Please see drawing on next page to assist in identifying parts.

SA2420DX

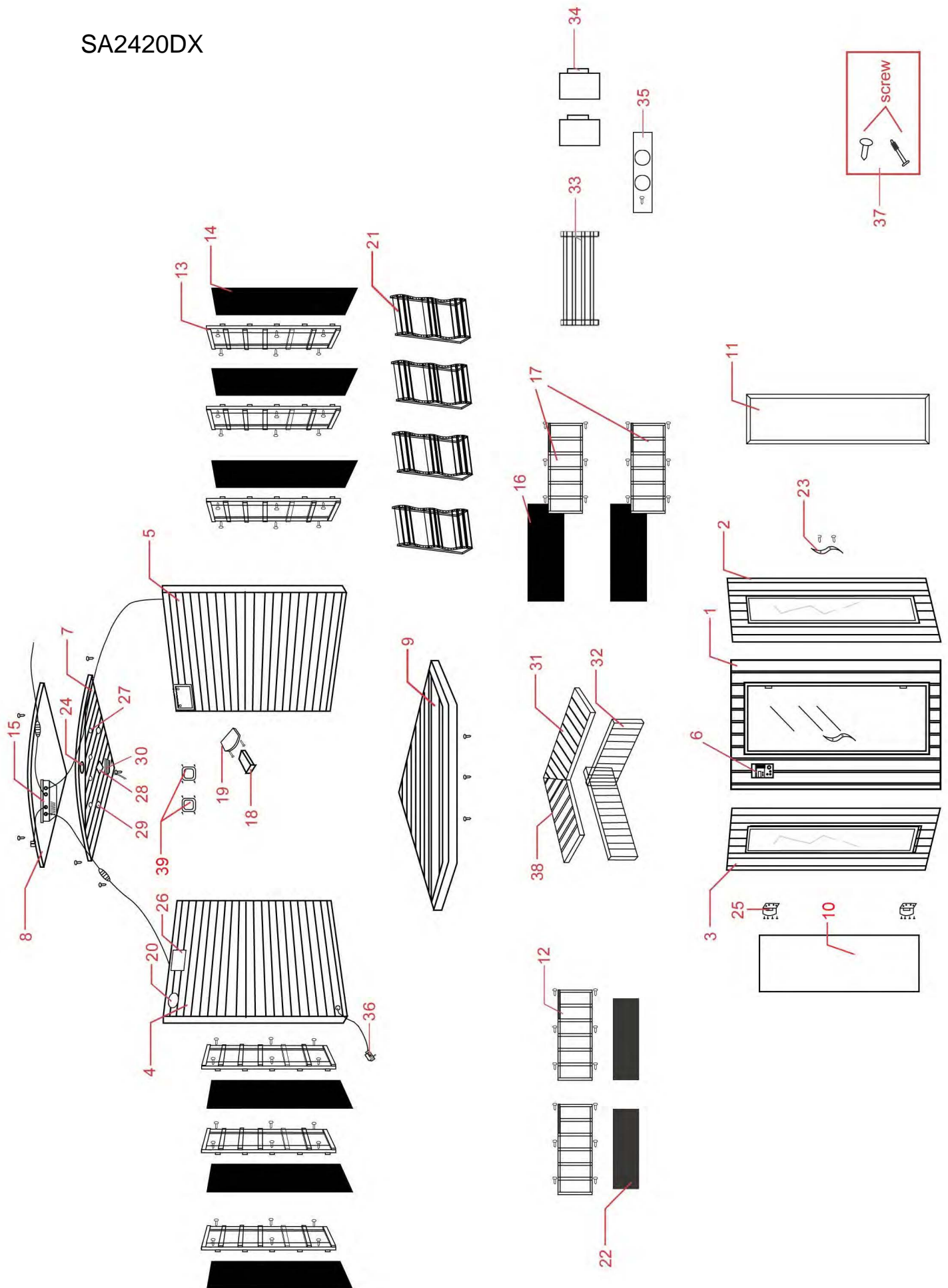

SAUNA WARRANTY REGISTRATION CARD

1. This sauna has a 5-Year Warranty against defects in materials and workmanship. To receive the warranty, the card must be filled out completely and returned. This 5-Year Warranty covers the sauna. The radio in your sauna is covered by a limited 1-Year Warranty.
2. Please notify Blue Wave Products in advance of any sauna warranty claim prior to shipping the sauna back. Contact our warranty claim department at warranty@splashnetxpress.com.
3. If the warranty claim department determines that the item must be returned, it must be returned with a receipt showing date of purchase, purchase price, and the dealer from which the sauna was purchased. **No warranty claim will be honored without a receipt.**
4. The freight on the item when returned must be prepaid.
5. Warranty claims will only be resolved with the repair of the current product or shipment of a replacement product. NO REFUNDS will be given.
6. Improper installation, misuse or damages resulting from acts of nature will render this warranty null and void.
7. This warranty is in lieu of all other warranties expressed or implied and no responsibility is assumed for future damage due to misuse. This sauna is intended for INDOOR USE ONLY – outdoor installation of the sauna WILL VOID THE WARRANTY. We are not responsible for damage to the sauna due to improper installation or misuse. Additional actions that will void the warranty are: Use of lacquer or paints, placing sauna on non-approved surface, and outdoor applications.

Surface cracks are not considered defects in material or workmanship, as they are normal characteristics of all wood.

To send in this warranty card: Fill out below, detach and mail to the following address:

**BLUE WAVE PRODUCTS
1745 Wallace Ave. Suite B
St. Charles, IL 60174**

Detach Here

Detach Here

SAUNA WARRANTY REGISTRATION FORM

Date Purchased: ____/____/____

Name: _____

Address: _____

City/State/Zip: _____

Phone: () _____ Email: _____

Purchased from: _____

Item Number: _____ Purchase Price: _____

Serial Number: _____